

L15-91-11

REV. 7/06

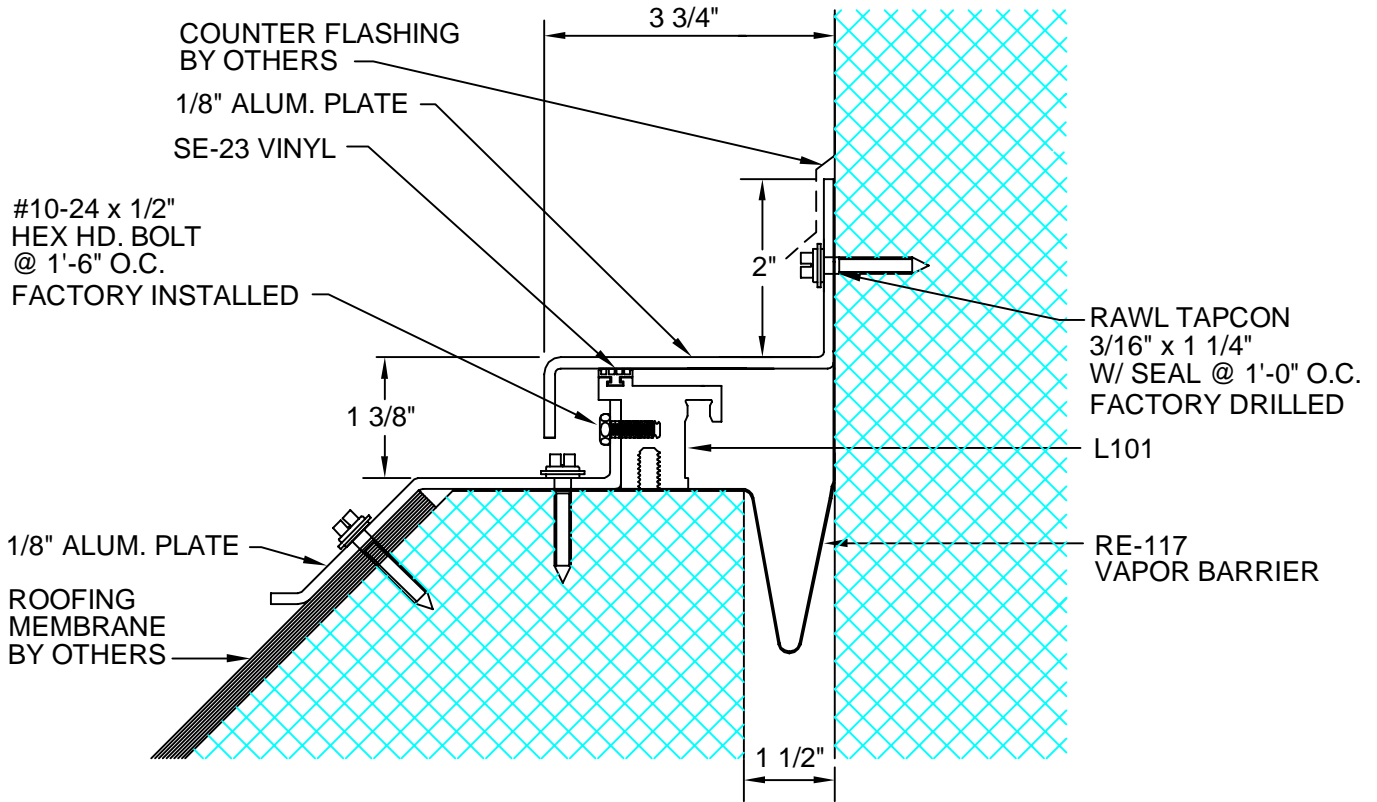

DESCRIPTION: EXTERIOR CORNER ROOF/WALL
 ALUMINUM: 6063-T5 EXTRUSION, 6061-T6 PLATE
 STAINLESS STEEL: 304 ALLOY
 EXPOSED FINISH: MILL
 ALLOWABLE LOAD: NOT DESIGNED FOR STRUCTURAL LOADS
 MOVEMENT: +/-25% JOINT WIDTH
 STOCK LENGTHS: 10'-0"

CUSTOMER:		
PROJECT:		
LOCATION:		
ARCHITECT:		
CONTRACTOR:		
NOTE:		
JOB NO.:	DATE:	SCALE: (NTS)

LENGTH:	QTY:	COLOR/FINISH:



ARCHITECTURAL ART MFG., INC.
 6409 RHODE ISLAND AVE. RIVERDALE, MD 20737

