

H60-63-14

REV. 2/08

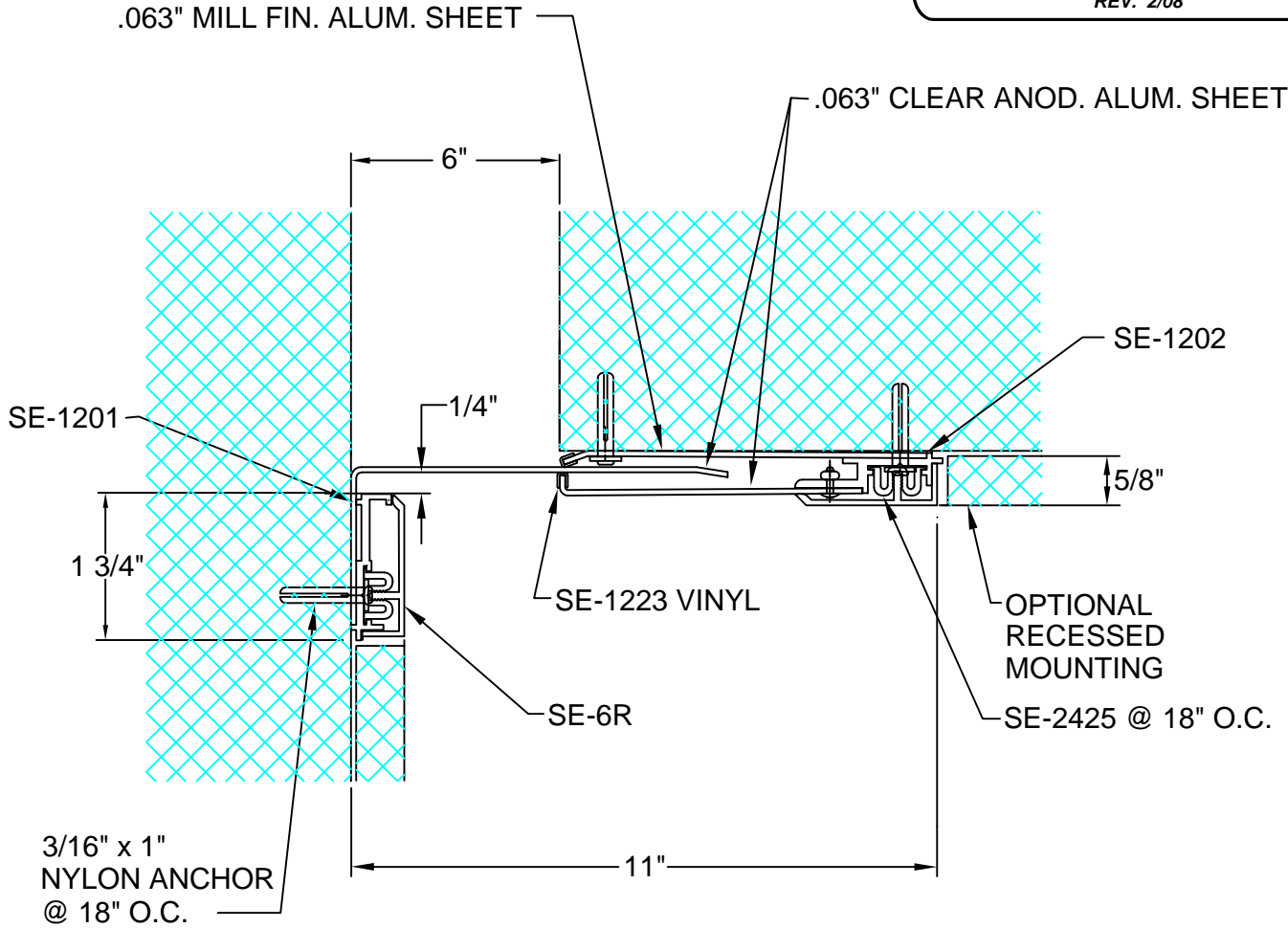

DESCRIPTION: WALL TO CORNER; CEILING TO WALL

ALUMINUM: 6063-T5 EXTRUSION, 3003-H14 SHEET

VINYL: 90 DURO PVC

EXPOSED FINISH: R1-204 CLEAR ANODIZED

ALLOWABLE LOAD: NOT DESIGNED FOR STRUCTURAL LOADS

MOVEMENT: +/- 25% JOINT WIDTH

STOCK LENGTHS: 10'-0"

CUSTOMER:		
PROJECT:		
LOCATION:		
ARCHITECT:		
CONTRACTOR:		
NOTE:		
JOB NO.:	DATE:	SCALE: (NTS)

MARK:	QTY:	LENGTH:	LOCATION:

ARCHITECTURAL ART MFG.

6409 RHODE ISLAND AVE. RIVERDALE, MD 20737 PHONE (800) 835-0028 FAX (316) 462-0511 WWW.ARCHART.COM