

COLOR SELECTOR	
BLACK _____	BROWN _____
BEIGE _____	GRAY _____
WHITE _____	

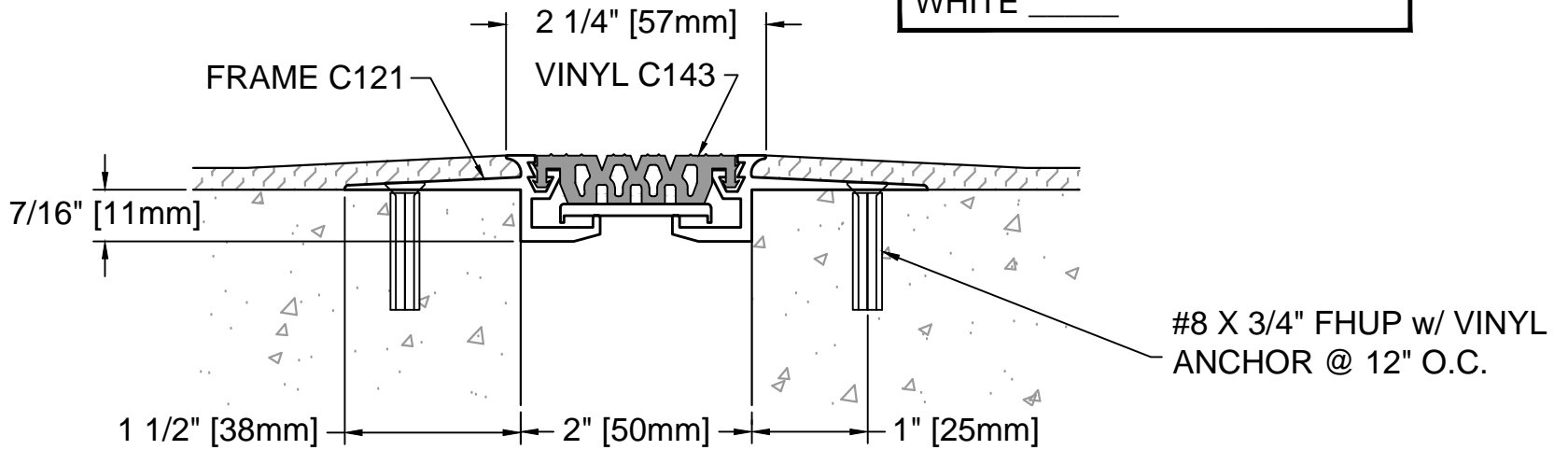

DESCRIPTION: FLOOR-TO-FLOOR  
ALUMINUM: 6063-T5 EXTRUSION  
VINYL: 70 DURO. PVC  
EXPOSED FINISH: MILL  
MOVEMENT: +/- 25% JOINT WIDTH  
STOCK LENGTHS: 20'-0"

**C20-14-41**  
REV. 4/08



**Architectural Art  
MANUFACTURING**

Division of Pittcon Architectural Metals, LLC  
283 SWANSON DRIVE, STE 103  
LAWRENCEVILLE, GA 30043  
PH: (678) 680-7373 FAX: (678) 735-0085  
TOLL FREE: (800) 835-0028 web: www.archart.com

**INTERIOR FLR - FLR SYSTEM**

MODEL: C20-14-41

DRAWN BY:  
NDC

SCALE:  
NTS

DRAWING NO.:  
**DTL-01**

SHT. 1 OF 1

ISSUE DATE:  
7/01/09

NO.	DESCRIPTION	BY	DATE

REVISIONS

The information contained herein is the proprietary property of **ARCHITECTURAL ART MFG.**, Division of Pittcon Architectural Metals, LLC. No portion of it may be reproduced by any means or used in any form except for the purpose for which it was furnished. All rights of design and invention are hereby reserved. We reserve the right to make changes in the design at our discretion.